

Article number: 2031100M2075C3TK
 Description: E+G levelling foot
 GN 31-100-M20-75-C3-TK
 Note: TK With nut, Wrench flat at the bottom

Measures

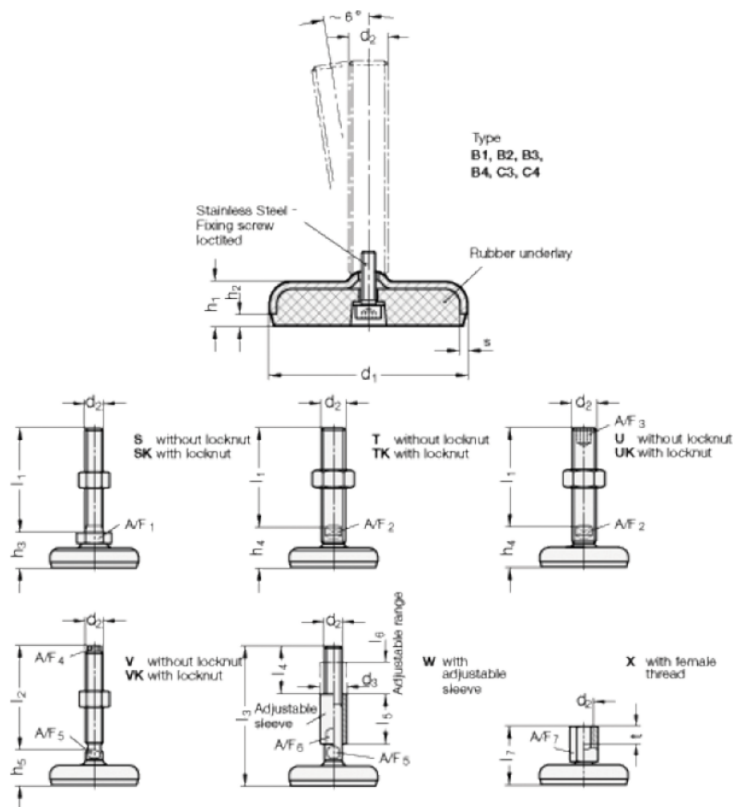

A/F2	= 15
d1	= 100
d2	= 20
h1	= 20
h2	= 6
h4 +4.0/0	= 35
l2	= 75
s	= 3